

ZOMM SERIES

ZOMM 127A / (XXX) / 1 / 4

(XXX)	400	401	402	403	404	405	406	407	408	409	410	411
Continuous Operating Voltage : a.c. (rms)	50	60	95	110	120	135	150	180	220	250	280	320
Energy per channel (Joules) (10/1000µs)	28	35	50	55	65	75	80	90	110	130	140	150
Max. Peak Clamping Volts at 50A (8/20µs)	180	210	-	-	-	-	-	-	-	-	-	-
Max. Peak Clamping Volts at 100A (8/20µs)	-	-	250	310	330	380	420	525	650	710	825	910

Characteristics:

No. of channels	4
50 Shot (4/20µs) Repetitive Duty	1000A
Response Time	<10ns
Continuous Current per Channel	20A
Max. (8/20µs) Current per Channel	6500A
Leakage Current per Channel at Rated Voltage, d.c.	<100µA
Through Inductance	<10µH
Volts Drop	Negligible
Terminations	4mm Dia. Brass
Bushes	PTFE
Earth Connection	To Base Plate
Recommended Torque per M4 Terminal	1.3Nm (Ensure terminal does not rotate)

ZOMM 127A / (XXX) / 1 / 4

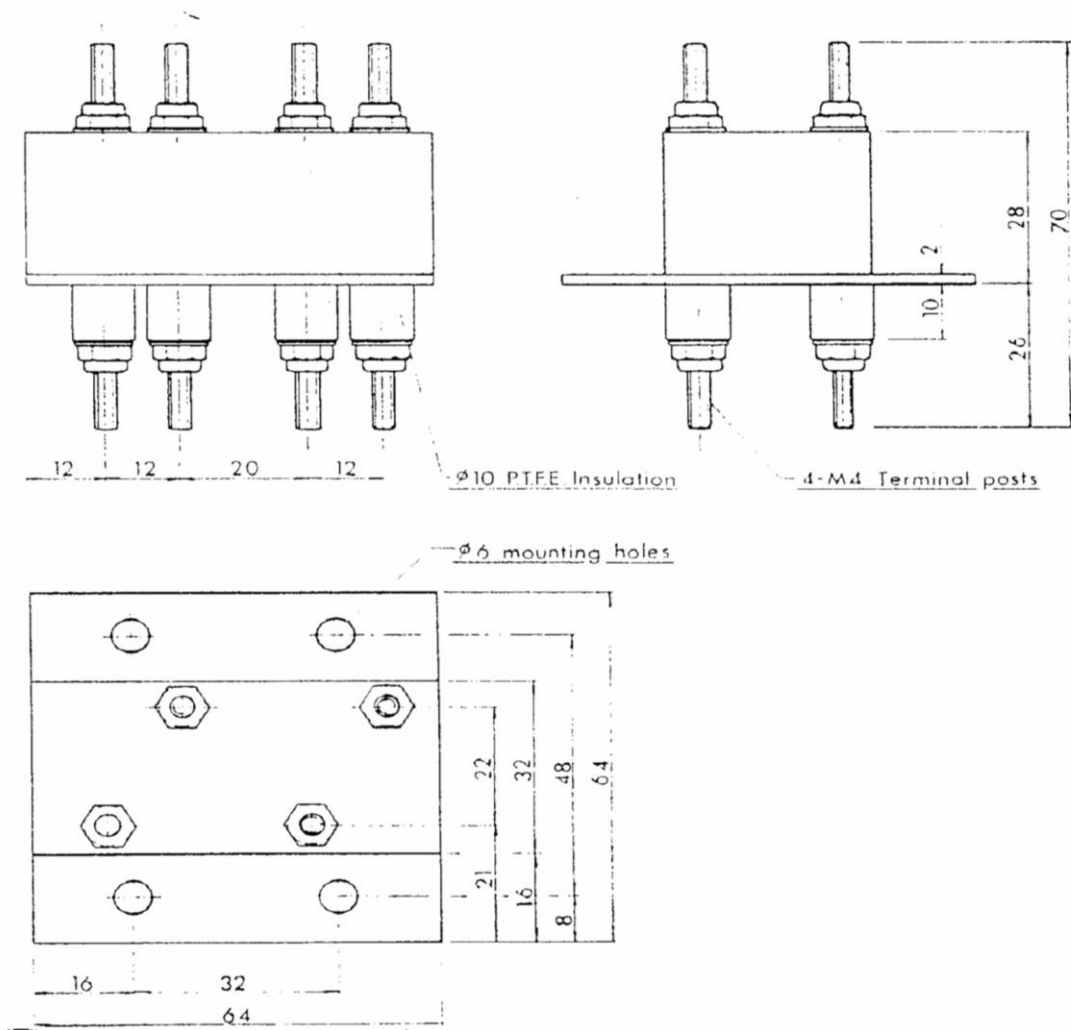

Contacts

**PD Devices Ltd
Old Station Yard,
South Brent,
Devon,
TQ10 9AL, UK.**

**Telephone : +44 01364 649248
Facsimile : +44 01364 649250
E-mail Enquiries : enquiries@pddevices.co.uk
Web Site : www.pddevices.co.uk**

enquiries@pddevices.co.uk

www.pddevices.co.uk

+44 (0)1364 649248